



Email - info@valordek.com

Phone - (604) 576 0754

Fax - (604) 576 1285

Toll Free - 1 (800) 400 6155

Address - 17514 55B Ave, Surrey, BC, V3S 7G6

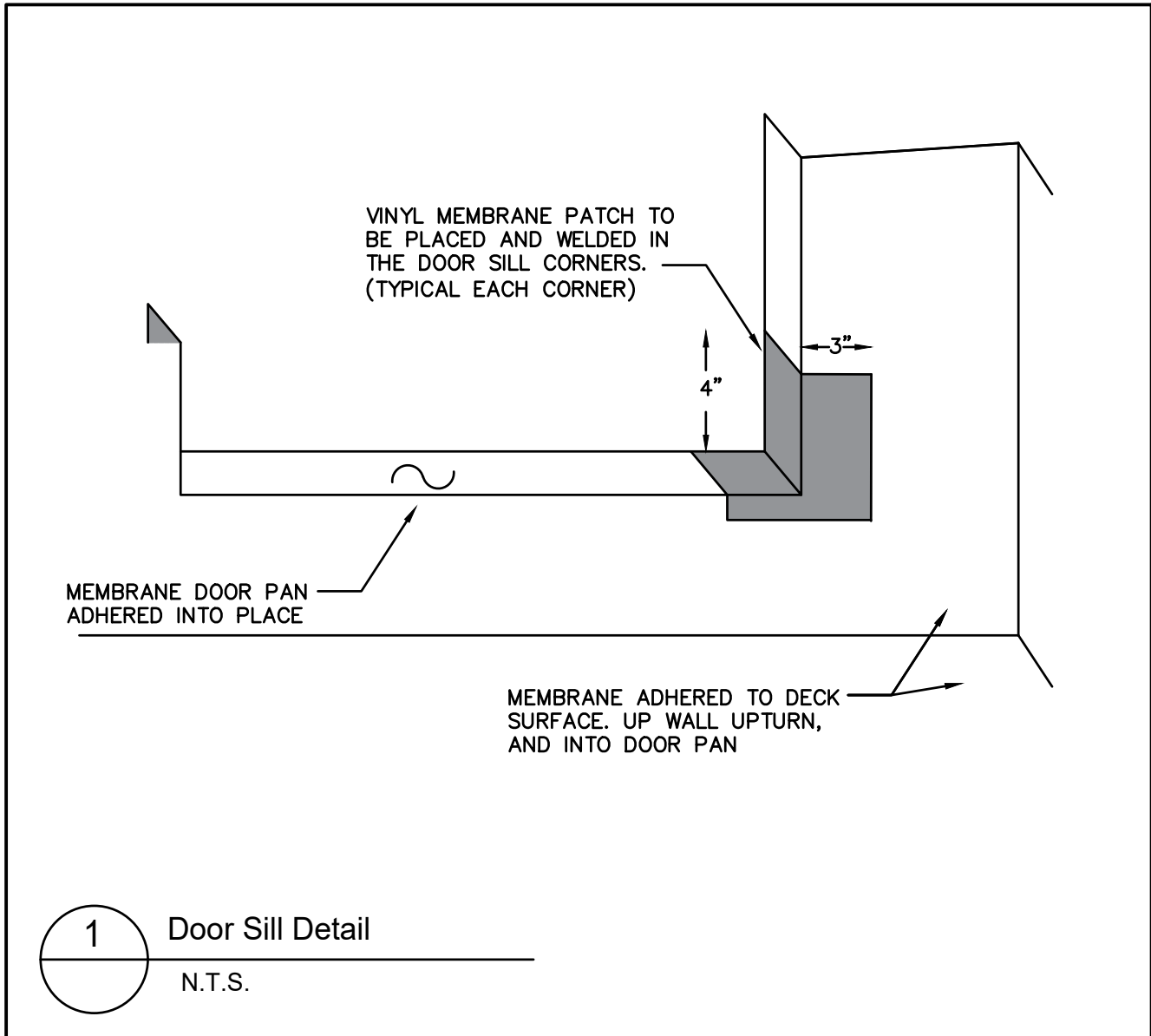

**Notes:**

As a supplier of a finished product only, Valordek Vinyl Product does not assume responsibility for errors in engineering, dimensions, or design. The architect, contractor or owner's representative must verify all suitability details

designed	scale	date
drawn	project no. Training	
checked	drawing no.	rev.
approved	VD-100	